



SPRING BALANCE | WINDOW HARDWARE RANGE



SPRING BALANCE WINDOW HARDWARE RANGE



SPRING BALANCE | WINDOW HARDWARE RANGE

SPRING BALANCE Suitable Windows	4
SPRING BALANCE Selecting the Spring	6
SPRING BALANCE Friction Feet	7
SPRING BALANCE Sash Weight Chart	8
SPRING BALANCE Components & Accessories	10
SPRING BALANCE Friction Feet Components	13

DOUBLE HUNG WINDOWS

Double Hung windows have been installed in Australian houses for decades.

The unique window design allows warm air to escape through the top of the window whilst drawing cool air in through the bottom. This circulation is ideal where ventilation is desired.

As Double Hung windows have become more common and sizes have become larger the challenge has been to provide reliable hardware to meet this requirement.

Doric draws on over 30 years of experience to offer a Spring Balance mechanism that is recognised as the most reliable maintenance free balance system available.



BALANCES TO SUIT ALUMINIUM WINDOWS

Designed to complement and work within the dimensional restraints of modern aluminium double hung windows.

The Doric Spring balance suits windows from 1.6kg through to 22kg providing a reliable easy to operate mechanism to balance a window.

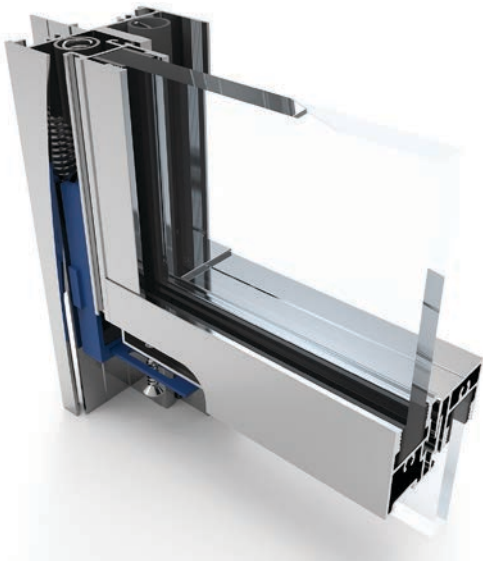

FEATURES

- Comprehensive range of sizes and strengths. (See size chart)
- Accessories available such as stops, guides, and friction feet.
- Durable materials provide reliability and longevity.
- Compatible with the majority of Australian Double Hung Windows and brands.
- Made in Australia

BALANCES TO SUIT TIMBER WINDOWS

The Timber spring balance is essentially the same mechanism as the aluminium variant with the addition of an aluminium channel. When installed the timber window is balanced and smooth.

There are two methods to install the Doric Spring Balance into a Timber Window:

METHOD 1

Trench the window frame to accommodate the supplied aluminium channel and balance mechanism. Install a timber bead to locate, secure, separate and seal each sash in its operation.

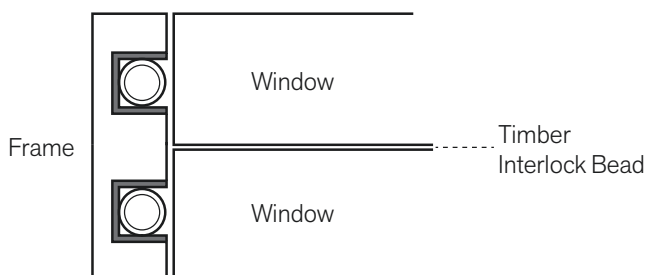

METHOD 2

Surface mount the channel to the frame. Machine the sash to the dimension of the channel allowing 1mm - 2mm clearance. The sash then travels up and down using the aluminium channel as a guide.

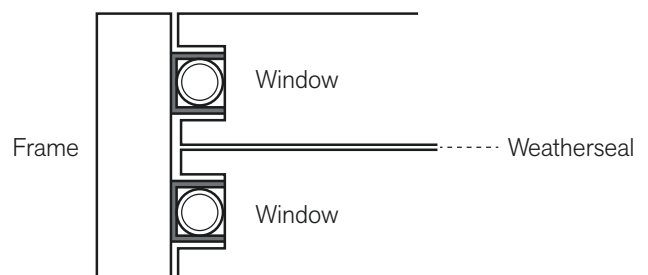

SELECTING THE CORRECT BALANCE

Spring balances are separated by length and strength. The height of the window determines the spring length, the weight of the window determines the spring strength.

To select the correct spring, measure the internal dimensions of the window. See figure 1.

Reference the height, the width and the glass thickness with the "SASH WEIGHT CHART".

Note: Round the measured window height up to the nearest value found in the chart.

For example; a window that measures 1230mm high, will require a spring with a length of 1299mm. If the width is 650mm and the glass thickness is 6mm a blue spring is required.

If you do not know the glass thickness the sash must be weighed and the weight referenced against the "SASH WEIGHT CHART".

6mm Glass - Sash Weight Chart		Window Width Range					
Window Height Range	Spring Length	600	650	700	750	800	850
699	179	3.3	3.5	3.8	4.1	4.4	4.6
799	229	3.7	4.1	4.4	4.7	5.0	5.3
899	279	4.2	4.6	4.9	5.3	5.6	6.0
999	329	4.7	5.1	5.5	5.8	6.2	6.6
1099	379	5.1	5.6	6.0	6.4	6.9	7.3
1199	429	5.6	6.1	6.5	7.0	7.5	7.9
1299	479	6.1	6.6	7.1	7.6	8.1	8.6
1399	529	6.5	7.1	7.6	8.2	8.7	9.3
1499	579	7.0	7.6	8.2	8.8	9.4	9.9
2499	1079	11.7	12.7	13.6	14.6	15.6	16.6

Source; 6mm Glass Sash Weight Chart

IDENTIFYING CORRECT COLOUR

Using the internal height and width axis, this is known as "daylight opening size". The Daylight Opening Size is the measurement to be applied to the Sash Weight Chart. Additionally, the glass thickness is required to identify the correct chart to use.

Figure 1.

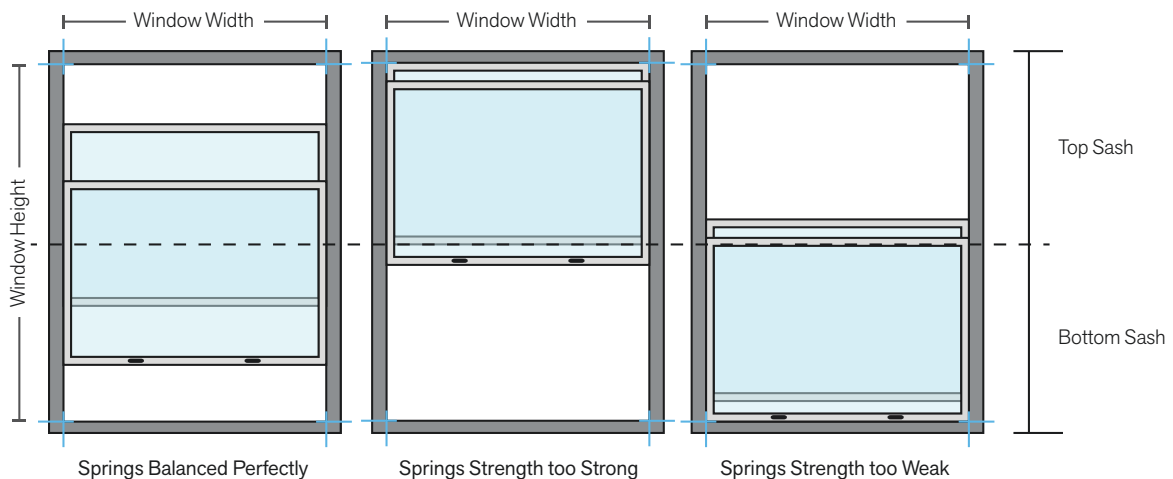

Once installed and without adjustment applied to the friction foot, **a correctly selected spring will balance the sash within the middle third of the window stroke.** If this is not the case the spring weight colour is not correct and the spring should be changed for the correct colour.

COLOUR CODES

Specific colour coding of the spring balances is clearly marked, visible on the spring ends and the tube end caps so you can cross check and ensure the right spring balance is used.

RED	YELLOW	WHITE	BLUE	GREEN	BLACK	GREY
0 - 2.75kg	2.75 - 4.25kg	4.25 - 6.00kg	6.00 - 10.00kg	10.00 - 14.00kg	14.00 - 18.00kg	18.00 - 22.00kg

Note: Grey Springs are not available for general sales. Consultation required and signed disclaimer. Functional performance is not guaranteed or warranted.

FRICTION FEET

Friction feet are required in every spring balance application. A friction foot is designed specifically to hold the window in the desired position. It is not designed to compensate for an incorrect spring strength. See **"SELECTING THE CORRECT BALANCE"**.

Once the correct spring balance length and weight (strength) is selected, the right friction needs to be applied. There is a variety of friction feet available to suit the majority of window suite dimensions with widths ranging from 13 mm to 35 mm.

To identify the correct friction foot, the window internal channel width (**X**) is required. For example, a 21 mm wide aluminium channel will require a friction foot of 21mm or less as so adjustment can be achieved.

A friction foot has approximately 3-4 mm of adjustment from it's base position.

If the window brand is known, Doric can provide the exact friction foot for the window. If the window brand isn't known simply measure the channel width where the friction foot will be located and include this dimension on your order sheet and your Doric representative will nominate the appropriate friction foot to suit your application.

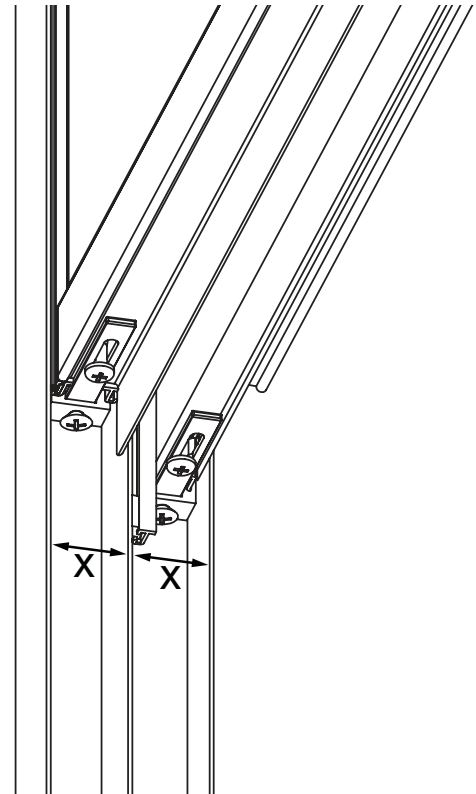

FRICTION FOOT ADJUSTMENT

Once the Spring Balance is installed and checked to be the correct weight for the window the following procedure should followed to tension the friction feet:

1. Loosen the friction foot adjustment screw until the friction foot no longer applies friction to the extrusion.
2. Cycle the sash (window) up and down several times to check if the friction feet are disengaged.
3. Tighten the friction foot adjustment screw until a small amount of tension is felt on the screw. Repeat on the opposing side.
4. Cycle the window again to make sure a small amount of friction is present.
5. Tighten the adjustment screw half a turn.
6. Cycle the window and attempt to set the window in the position where the spring is not in tension. The window should remain in place. If the window moves add another half turn to the friction feet and check again.
7. Tighten the adjustment screw an additional quarter turn to account for wear in the friction foot.

Your window should now be correctly balanced.



CAUTION: Never use a power drill to adjust a friction foot or over tension the adjustment screw. This causes the friction foot to distort and can damage the window channel surface.

SPRING BALANCE | SASH WEIGHT CHART

3mm Glass - Sash Weight Chart		Window Width Range																
Window Height Range	Spring Length	600	650	700	750	800	850	900	950	1000	1050	1100	1150	1200	1250	1300	1350	1400
699	179	1.6	1.7	1.8	2.0	2.1	2.2	2.4	2.5	2.6	2.8	2.9	3.0	3.1	3.3	3.4	3.5	3.7
799	229	1.8	1.9	2.1	2.2	2.4	2.5	2.7	2.8	3.0	3.1	3.3	3.4	3.6	3.7	3.9	4.0	4.2
899	279	2.0	2.2	2.4	2.5	2.7	2.9	3.0	3.2	3.4	3.5	3.7	3.9	4.0	4.2	4.4	4.6	4.7
999	329	2.2	2.4	2.6	2.8	3.0	3.2	3.4	3.6	3.7	3.9	4.1	4.3	4.5	4.7	4.9	5.1	5.2
1099	379	2.5	2.7	2.9	3.1	3.3	3.5	3.7	3.9	4.1	4.3	4.5	4.7	4.9	5.2	5.4	5.6	5.8
1199	429	2.7	2.9	3.1	3.4	3.6	3.8	4.0	4.3	4.5	4.7	4.9	5.2	5.4	5.6	5.8	6.1	6.3
1299	479	2.9	3.2	3.4	3.7	3.9	4.1	4.4	4.6	4.9	5.1	5.4	5.6	5.8	6.1	6.3	6.6	6.8
1399	529	3.1	3.4	3.7	3.9	4.2	4.5	4.7	5.0	5.2	5.5	5.8	6.0	6.3	6.6	6.8	7.1	7.3
1499	579	3.4	3.7	3.9	4.2	4.5	4.8	5.1	5.3	5.6	5.9	6.2	6.5	6.7	7.0	7.3	7.6	7.9
1599	629	3.6	3.9	4.2	4.5	4.8	5.1	5.4	5.7	6.0	6.3	6.6	6.9	7.2	7.5	7.8	8.1	8.4
1699	679	3.8	4.1	4.5	4.8	5.1	5.4	5.7	6.1	6.4	6.7	7.0	7.3	7.6	8.0	8.3	8.6	8.9
1799	729	4.0	4.4	4.7	5.1	5.4	5.7	6.1	6.4	6.7	7.1	7.4	7.8	8.1	8.4	8.8	9.1	9.4
1899	779	4.3	4.6	5.0	5.3	5.7	6.1	6.4	6.8	7.1	7.5	7.8	8.2	8.5	8.9	9.3	9.6	10.0
1999	829	4.5	4.9	5.2	5.6	6.0	6.4	6.7	7.1	7.5	7.9	8.2	8.6	9.0	9.4	9.7	10.1	10.5
2099	879	4.7	5.1	5.5	5.9	6.3	6.7	7.1	7.5	7.9	8.3	8.7	9.1	9.4	9.8	10.2	10.6	11.0
2199	929	4.9	5.4	5.8	6.2	6.6	7.0	7.4	7.8	8.2	8.7	9.1	9.5	9.9	10.3	10.7	11.1	11.5
2299	979	5.2	5.6	6.0	6.5	6.9	7.3	7.8	8.2	8.6	9.1	9.5	9.9	10.3	10.8	11.2	11.6	12.1
2399	1029	5.4	5.8	6.3	6.7	7.2	7.6	8.1	8.5	9.0	9.4	9.9	10.3	10.8	11.2	11.7	12.1	12.6
2499	1079	5.6	6.1	6.6	7.0	7.5	8.0	8.4	8.9	9.4	9.8	10.3	10.8	11.2	11.7	12.2	12.7	13.1

4mm Glass - Sash Weight Chart		Window Width Range																
Window Height Range	Spring Length	600	650	700	750	800	850	900	950	1000	1050	1100	1150	1200	1250	1300	1350	1400
699	179	2.1	2.3	2.4	2.6	2.8	3.0	3.1	3.3	3.5	3.7	3.8	4.0	4.2	4.4	4.5	4.7	4.9
799	229	2.4	2.6	2.8	3.0	3.2	3.4	3.6	3.8	4.0	4.2	4.4	4.6	4.8	5.0	5.2	5.4	5.6
899	279	2.7	2.9	3.1	3.4	3.6	3.8	4.0	4.3	4.5	4.7	4.9	5.2	5.4	5.6	5.8	6.1	6.3
999	329	3.0	3.2	3.5	3.7	4.0	4.2	4.5	4.7	5.0	5.2	5.5	5.7	6.0	6.2	6.5	6.7	7.0
1099	379	3.3	3.6	3.8	4.1	4.4	4.7	4.9	5.2	5.5	5.8	6.0	6.3	6.6	6.9	7.1	7.4	7.7
1199	429	3.6	3.9	4.2	4.5	4.8	5.1	5.4	5.7	6.0	6.3	6.6	6.9	7.2	7.5	7.8	8.1	8.4
1299	479	3.9	4.2	4.5	4.9	5.2	5.5	5.8	6.2	6.5	6.8	7.1	7.5	7.8	8.1	8.4	8.8	9.1
1399	529	4.2	4.5	4.9	5.2	5.6	5.9	6.3	6.6	7.0	7.3	7.7	8.0	8.4	8.7	9.1	9.4	9.8
1499	579	4.5	4.9	5.2	5.6	6.0	6.4	6.7	7.1	7.5	7.9	8.2	8.6	9.0	9.4	9.7	10.1	10.5
1599	629	4.8	5.2	5.6	6.0	6.4	6.8	7.2	7.6	8.0	8.4	8.8	9.2	9.6	10.0	10.4	10.8	11.2
1699	679	5.1	5.5	5.9	6.4	6.8	7.2	7.6	8.1	8.5	8.9	9.3	9.8	10.2	10.6	11.0	11.5	11.9
1799	729	5.4	5.8	6.3	6.7	7.2	7.6	8.1	8.5	9.0	9.4	9.9	10.3	10.8	11.2	11.7	12.1	12.6
1899	779	5.7	6.2	6.6	7.1	7.6	8.1	8.5	9.0	9.5	10.0	10.4	10.9	11.4	11.9	12.3	12.8	13.3
1999	829	6.0	6.5	7.0	7.5	8.0	8.5	9.0	9.5	10.0	10.5	11.0	11.5	12.0	12.5	13.0	13.5	14.0
2099	879	6.3	6.8	7.3	7.9	8.4	8.9	9.4	10.0	10.5	11.0	11.5	12.1	12.6	13.1	13.6	14.2	14.7
2199	929	6.6	7.1	7.7	8.2	8.8	9.3	9.9	10.4	11.0	11.5	12.1	12.6	13.2	13.7	14.3	14.8	15.4
2299	979	6.9	7.5	8.0	8.6	9.2	9.8	10.3	10.9	11.5	12.1	12.6	13.2	13.8	14.4	14.9	15.5	16.1
2399	1029	7.2	7.8	8.4	9.0	9.6	10.2	10.8	11.4	12.0	12.6	13.2	13.8	14.4	15.0	15.6	16.2	16.8
2499	1079	7.5	8.1	8.7	9.4	10.0	10.6	11.2	11.9	12.5	13.1	13.7	14.4	15.0	15.6	16.2	16.9	17.5

5mm Glass - Sash Weight Chart		Window Width Range																
Window Height Range	Spring Length	600	650	700	750	800	850	900	950	1000	1050	1100	1150	1200	1250	1300	1350	1400
699	179	2.6	2.8	3.1	3.3	3.5	3.7	3.9	4.2	4.4	4.6	4.8	5.0	5.2	5.5	5.7	5.9	6.1
799	229	3.0	3.2	3.5	3.7	4.0	4.2	4.5	4.7	5.0	5.2	5.5	5.7	6.0	6.2	6.5	6.7	7.0
899	279	3.4	3.7	3.9	4.2	4.5	4.8	5.1	5.3	5.6	5.9	6.2	6.5	6.7	7.0	7.3	7.6	7.9
999	329	3.7	4.1	4.4	4.7	5.0	5.3	5.6	5.9	6.2	6.6	6.9	7.2	7.5	7.8	8.1	8.4	8.7
1099	379	4.1	4.5	4.8	5.2	5.5	5.8	6.2	6.5	6.9	7.2	7.6	7.9	8.2	8.6	8.9	9.3	9.6
1199	429	4.5	4.9	5.2	5.6	6.0	6.4	6.7	7.1	7.5	7.9	8.2	8.6	9.0	9.4	9.7	10.1	10.5
1299	479	4.9	5.3	5.7	6.1	6.5	6.9	7.3	7.7	8.1	8.5	8.9	9.3	9.7	10.1	10.6	11.0	11.4
1399	529	5.2	5.7	6.1	6.6	7.0	7.4	7.9	8.3	8.7	9.2	9.6	10.1	10.5	10.9	11.4	11.8	12.2
1499	579	5.6	6.1	6.6	7.0	7.5	8.0	8.4	8.9	9.4	9.8	10.3	10.8	11.2	11.7	12.2	12.6	13.1
1599	629	6.0	6.5	7.0	7.5	8.0	8.5	9.0	9.5	10.0	10.5	11.0	11.5	12.0	12.5	13.0	13.5	14.0
1699	679	6.4	6.9	7.4	8.0	8.5	9.0	9.6	10.1	10.6	11.1	11.7	12.2	12.7	13.3	13.8	14.3	14.9
1799	729	6.7	7.3	7.9	8.4	9.0	9.6	10.1	10.7	11.2	11.8	12.4	12.9	13.5	14.1	14.6	15.2	15.7
1899	779	7.1	7.7	8.3	8.9	9.5	10.1	10.7	11.3	11.9	12.5	13.1	13.6	14.2	14.8	15.4	16.0	16.6
1999	829	7.5	8.1	8.7	9.4	10.0	10.6	11.2	11.9	12.5	13.1	13.7	14.4	15.0	15.6	16.2	16.9	17.5
2099	879	7.9	8.5	9.2	9.8	10.5	11.1	11.8	12.5	13.1	13.8	14.4	15.1	15.7	16.4	17.1	17.7	18.4
2199	929	8.2	8.9	9.6	10.3	11.0	11.7	12.4	13.1	13.7	14.4	15.1	15.8	16.5	17.2	17.9	18.6	19.2
2299	979	8.6	9.3	10.1	10.8	11.5	12.2	12.9	13.7	14.4	15.1	15.8	16.5	17.2	18.0	18.7	19.4	20.1
2399	1029	9.0	9.7	10.5	11.2	12.0	12.7	13.5	14.2	15.0	15.7	16.5	17.2	18.0	18.7	19.5	20.2	21.0
2499	1079	9.4	10.2	10.9	11.7	12.5	13.3	14.1	14.8	15.6	16.4	17.2	18.0	18.7	19.5	20.3	21.1	21.9

Note: Grey Springs are not available for general sales. Consultation required and signed disclaimer. Functional performance is not guaranteed or warranted.

SPRING BALANCE | SASH WEIGHT CHART

6mm Glass - Sash Weight Chart		Window Width Range																
Window Height Range	Spring Length	600	650	700	750	800	850	900	950	1000	1050	1100	1150	1200	1250	1300	1350	1400
699	179	3.3	3.5	3.8	4.1	4.4	4.6	4.9	5.2	5.5	5.7	6.0	6.3	6.5	6.8	7.1	7.4	7.6
799	229	3.7	4.1	4.4	4.7	5.0	5.3	5.6	5.9	6.2	6.5	6.9	7.2	7.5	7.8	8.1	8.4	8.7
899	279	4.2	4.6	4.9	5.3	5.6	6.0	6.3	6.7	7.0	7.4	7.7	8.1	8.4	8.8	9.1	9.5	9.8
999	329	4.7	5.1	5.5	5.8	6.2	6.6	7.0	7.4	7.8	8.2	8.6	9.0	9.4	9.7	10.1	10.5	10.9
1099	379	5.1	5.6	6.0	6.4	6.9	7.3	7.7	8.1	8.6	9.0	9.4	9.9	10.3	10.7	11.1	11.6	12.0
1199	429	5.6	6.1	6.5	7.0	7.5	7.9	8.4	8.9	9.4	9.8	10.3	10.8	11.2	11.7	12.2	12.6	13.1
1299	479	6.1	6.6	7.1	7.6	8.1	8.6	9.1	9.6	10.1	10.6	11.1	11.7	12.2	12.7	13.2	13.7	14.2
1399	529	6.5	7.1	7.6	8.2	8.7	9.3	9.8	10.4	10.9	11.5	12.0	12.5	13.1	13.6	14.2	14.7	15.3
1499	579	7.0	7.6	8.2	8.8	9.4	9.9	10.5	11.1	11.7	12.3	12.9	13.4	14.0	14.6	15.2	15.8	16.4
1599	629	7.5	8.1	8.7	9.4	10.0	10.6	11.2	11.8	12.5	13.1	13.7	14.3	15.0	15.6	16.2	16.8	17.5
1699	679	8.0	8.6	9.3	9.9	10.6	11.3	11.9	12.6	13.3	13.9	14.6	15.2	15.9	16.6	17.2	17.9	18.6
1799	729	8.4	9.1	9.8	10.5	11.2	11.9	12.6	13.3	14.0	14.7	15.4	16.1	16.8	17.5	18.2	18.9	19.6
1899	779	8.9	9.6	10.4	11.1	11.8	12.6	13.3	14.1	14.8	15.6	16.3	17.0	17.8	18.5	19.3	20.0	20.7
1999	829	9.4	10.1	10.9	11.7	12.5	13.3	14.0	14.8	15.6	16.4	17.2	17.9	18.7	19.5	20.3	21.0	21.8
2099	879	9.8	10.6	11.5	12.3	13.1	13.9	14.7	15.6	16.4	17.2	18.0	18.8	19.6	20.5	21.3		
2199	929	10.3	11.1	12.0	12.9	13.7	14.6	15.4	16.3	17.2	18.0	18.9	19.7	20.6	21.4			
2299	979	10.8	11.7	12.6	13.4	14.3	15.2	16.1	17.0	17.9	18.8	19.7	20.6	21.5				
2399	1029	11.2	12.2	13.1	14.0	15.0	15.9	16.8	17.8	18.7	19.6	20.6	21.5					
2499	1079	11.7	12.7	13.6	14.6	15.6	16.6	17.5	18.5	19.5	20.5	21.4						

8mm Glass - Sash Weight Chart		Window Width Range																
Window Height Range	Spring Length	600	650	700	750	800	850	900	950	1000	1050	1100	1150	1200	1250	1300	1350	1400
699	179	4.2	4.5	4.9	5.2	5.6	5.9	6.3	6.6	7.0	7.3	7.7	8.0	8.4	8.7	9.1	9.4	9.8
799	229	4.8	5.2	5.6	6.0	6.4	6.8	7.2	7.6	8.0	8.4	8.8	9.2	9.6	10.0	10.4	10.8	11.2
899	279	5.4	5.8	6.3	6.7	7.2	7.6	8.1	8.5	9.0	9.4	9.9	10.3	10.8	11.2	11.7	12.1	12.6
999	329	6.0	6.5	7.0	7.5	8.0	8.5	9.0	9.5	10.0	10.5	11.0	11.5	12.0	12.5	13.0	13.5	14.0
1099	379	6.6	7.1	7.7	8.2	8.8	9.3	9.9	10.4	11.0	11.5	12.1	12.6	13.2	13.7	14.3	14.8	15.4
1199	429	7.2	7.8	8.4	9.0	9.6	10.2	10.8	11.4	12.0	12.6	13.2	13.5	14.4	15.0	15.6	16.2	16.8
1299	479	7.8	8.4	9.1	9.7	10.4	11.0	11.7	12.3	13.0	13.6	14.3	14.9	15.6	16.2	16.9	17.5	18.2
1399	529	8.4	9.1	9.8	10.5	11.2	11.9	12.6	13.3	14.0	14.7	15.4	16.1	16.8	17.5	18.2	18.9	19.6
1499	579	9.0	9.7	10.5	11.2	12.0	12.7	13.5	14.2	15.0	15.7	16.5	17.2	18.0	18.7	19.5	20.2	21.0
1599	629	9.6	10.4	11.2	12.0	12.8	13.6	14.4	15.2	16.0	16.8	17.6	18.4	19.2	20.0	20.8	21.6	
1699	679	10.2	11.0	11.9	12.7	13.6	14.4	15.3	16.1	17.0	17.8	18.7	19.5	20.4	21.2			
1799	729	10.8	11.7	12.6	13.5	14.4	15.3	16.2	17.1	18.0	18.9	19.8	20.7	21.6				
1899	779	11.4	12.3	13.3	14.2	15.2	16.1	17.1	18.0	19.0	19.9	20.9	21.8					
1999	829	12.0	13.0	14.0	15.0	16.0	17.0	18.0	19.0	20.0	21.0	22.0						
2099	879	12.6	13.6	14.7	15.7	16.8	17.8	18.9	19.9	21.0								
2199	929	13.2	14.3	15.4	16.5	17.6	18.7	19.8	20.9	22.0								
2299	979	13.8	14.9	16.1	17.2	18.4	19.5	20.7	21.8									
2399	1029	14.4	15.6	16.8	18.0	19.2	20.4	21.6										
2499	1079	15.0	16.2	17.5	18.7	20.0	21.2											

10mm Glass - Sash Weight Chart		Window Width Range																
Window Height Range	Spring Length	600	650	700	750	800	850	900	950	1000	1050	1100	1150	1200	1250	1300	1350	1400
699	179	5.2	5.7	6.1	6.6	7.0	7.4	7.9	8.3	8.7	9.2	9.6	10.0	10.5	10.9	11.4	11.8	12.2
799	229	6.0	6.5	7.0	7.5	8.0	8.5	9.0	9.5	10.0	10.5	11.0	11.5	12.0	12.5	13.0	13.5	14.0
899	279	6.7	7.3	7.9	8.4	9.0	9.6	10.1	10.7	11.2	11.8	12.4	12.9	13.5	14.0	14.6	15.2	15.7
999	329	7.5	8.1	8.7	9.4	10.0	10.6	11.2	11.9	12.5	13.1	13.7	14.4	15.0	15.6	16.2	16.9	17.5
1099	379	8.2	8.9	9.6	10.3	11.0	11.7	12.4	13.1	13.7	14.4	15.1	15.8	16.5	17.2	17.9	18.5	19.2
1199	429	9.0	9.7	10.5	11.2	12.0	12.7	13.5	14.2	15.0	15.7	16.5	17.2	18.0	18.7	19.5	20.2	21.0
1299	479	9.7	10.6	11.4	12.2	13.0	13.8	14.6	15.4	16.2	17.0	17.9	18.7	19.5	20.3	21.1	21.9	
1399	529	10.5	11.4	12.2	13.1	14.2	14.9	15.7	16.6	17.5	18.4	19.2	20.1	21.0				
1499	579	11.2	12.2	13.1	14.1	15.0	15.9	16.9	17.8	18.7	19.7	20.6	21.5					
1599	629	12.0	13.0	14.0	15.0	16.0	17.0	18.0	19.0	20.0	21.0	22.0						
1699	679	12.7	13.8	14.9	15.9	17.0	18.1	19.1	20.2	21.2								
1799	729	13.5	14.6	15.7	16.9	18.0	19.1	20.2	21.4									
1899	779	14.2	15.4	16.6	17.8	19.0	20.2	21.4										
1999	829	15.0	16.2	17.5	18.7	20.0	21.2											
2099	879	15.7	17.1	18.4	18.4	19.7	21.0											
2199	929	16.5	17.9	19.2	20.6	22.0												
2299	979	17.2	18.7	20.1	21.6													
2399	1029	18.0	19.5	21.0														
2499	1079	18.7	20.3	21.9														

Note: Grey Springs are not available for general sales. Consultation required and signed disclaimer. Functional performance is not guaranteed or warranted.

SPRING BALANCE | COMPONENTS & ACCESSORIES

DB0215 | SASH GUIDE

MATERIAL	Engineered Plastic
ORDER CODE	9000165

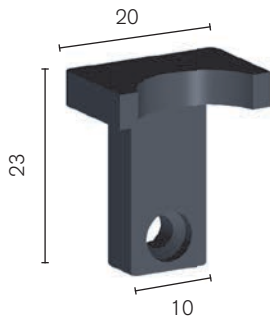

DB0327 | ADJUSTABLE SLIDING WINDOW CARRIAGE

MATERIAL	Polesium™
OPTIONS	Large - DB0327L Small - DB0327S
ORDER CODE	9000263



DB0341 | DOUBLE HUNG SASH STOP

MATERIAL	Engineered Plastic
ORDER CODE	9003259

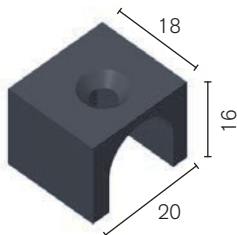

DB0344 | DOUBLE HUNG SASH STOP

MATERIAL	Engineered Plastic
ORDER CODE	9000281

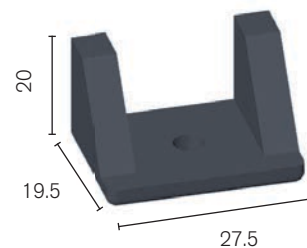

SPRING BALANCE | COMPONENTS & ACCESSORIES

DB0483 | DOUBLE HUNG STOP

MATERIAL	Engineered Plastic
ORDER CODE	9002504

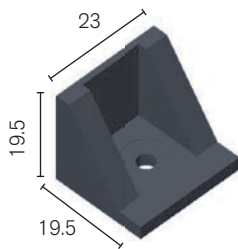

DB0502 | BOOT

WINDOW SUITE	Alcan or Capral System
MATERIAL	Engineered Plastic
ORDER CODE	9000804

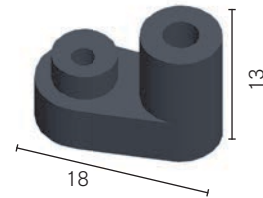

DB0510 | DOUBLE HUNG GUIDE

WINDOW SUITE	Alcan or Capral System
MATERIAL	Engineered Plastic
ORDER CODE	9002679

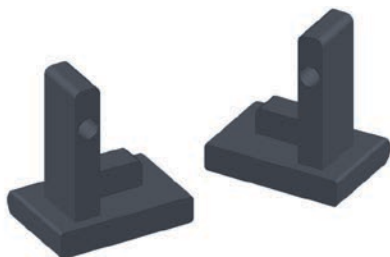

DB0511 | SPRING COVER

WINDOW SUITE	Alcan or Capral System
LENGTH	4m
ORDER CODE	9000806

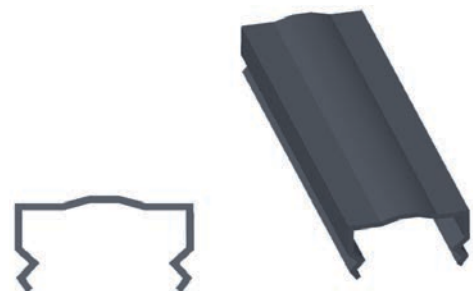

SPRING BALANCE | COMPONENTS & ACCESSORIES

DB0692 | POLY TUBING

APPLICATION	Suits Spring Balances
DIMENSIONS	Length: 4m Int. Dia: 11.5 Ext Dia: 13mm
FINISH	Black

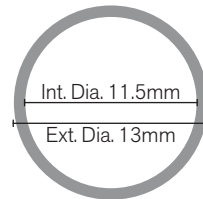

Not available for individual sale.
Included with Spring Balance orders



DB0714 | FRICTION BLOCK

WINDOW SUITE	Stegbar
ORDER CODE	9003593

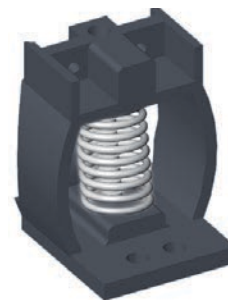

SPRING BALANCE | FRICTION FEET COMPONENTS

DB0708 | ADJUSTABLE FRICTION FOOT

WINDOW SUITE	Vincent Windows
APPLICATION	Suits 23mm - 25mm channels
ORDER CODE	9001002



DB0708/R | ADJUSTABLE FRICTION FOOT (REVERSE ASSEMBLY)

WINDOW SUITE	Capral
APPLICATION	Suits 23mm - 25mm channels
ORDER CODE	9005363



DB0718 | ADJUSTABLE FRICTION FOOT

DETAIL	With 53mm Connector
WINDOW SUITE	Wintec
APPLICATION	Suits 23-25mm channels
ORDER CODE	9005417



SPRING BALANCE | FRICTION FEET

DB0721 | ADJUSTABLE FRICTION FOOT

WINDOW SUITE	Bradnams
APPLICATION	Suits 23mm channels
ORDER CODE	9008932 - LH 9008933 - RH



DB0722 | ADJUSTABLE FRICTION FOOT

WINDOW SUITE	PWD Suite No.2
APPLICATION	Suits 32-35mm channels
ORDER CODE	9007743



DB0723 | ADJUSTABLE FRICTION FOOT - STD

WINDOW SUITE	Wideline
APPLICATION	Suits 23mm - 25mm channels
ORDER CODE	9008931

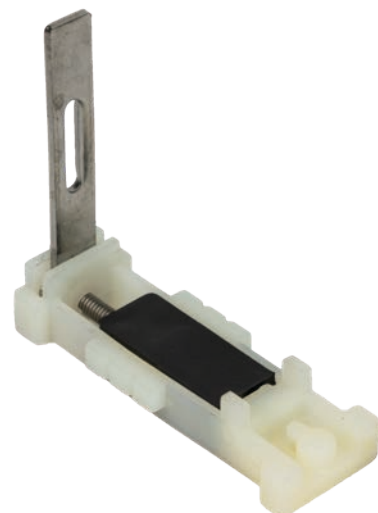

SPRING BALANCE | FRICTION FEET

DB0723/R | ADJUSTABLE FRICTION FOOT (REVERSE ASSEMBLY)

WINDOW SUITE	Wideline
APPLICATION	Suits 23mm - 25mm channels
ORDER CODE	9106015



DB0724 | ADJUSTABLE FRICTION FOOT

WINDOW SUITE	G.James
APPLICATION	Suits 20mm - 22mm channels
ORDER CODE	9010640



DB0725 | ADJUSTABLE FRICTION FOOT

WINDOW SUITE	BGC Window
APPLICATION	Suits 28mm channels
ORDER CODE	9018157



DB0726 | ADJUSTABLE FRICTION FOOT

See DB0708/R

INNOVATORS

OF HARDWARE FOR WINDOWS AND DOORS

INDEX

Code	Product/Description	Page
DB0215	Sash Guide	10
DB0327	Adjustable Sliding Window Carriage	10
DB0341	Double Hung Sash Stop	10
DB0344	Double Hung Sash Stop	10
DB0483	Double Hung Stop	11
DB0502	Boot	11
DB0510	Double Hung Guide	11
DB0511	Spring Cover	11
DB0692	Poly Tubing	12
DB0708	Adjustable Friction Foot	13
DB0708/R	Adjustable Friction Foot (Reverse Assembly)	13
DB0714	Friction Block	12
DB0718	Adjustable Friction Foot	13
DB0721	Adjustable Friction Foot	14
DB0722	Adjustable Friction Foot	14
DB0723	Adjustable Friction Foot - STD	14
DB0723/R	Adjustable Friction Foot (Reverse Assembly)	15
DB0724	Adjustable Friction Foot	15
DB0725	Adjustable Friction Foot	15
DB0726	See DB0708/R	15

SYDNEY

38 Redfern St,
Wetherill Park
Sydney, NSW 2164
Australia
Ph: +61 2 9609 2555
www.doric.com.au

AUCKLAND

26/C Triton Drive,
Albany, North Shore,
Auckland 0632
New Zealand
Ph: +64 9 415 5535
www.doric.co.nz

KUALA LUMPUR

Unit 6, Level 4, SetiaWalk Mall (Block K),
SetiaWalk, Persiaran Wawasan,
Pusat Bandar Puchong,
47160 Puchong, Selangor, Malaysia
Ph: +603 8602 2100
www.doric.com.my

