



---

# HINGES

DOOR & WINDOW  
HARDWARE



# HINGES DOOR & WINDOW HARDWARE



## **SECURITY** | DOOR HINGES

DH10   Step-over Security Door Hinge (w/ lug)	<b>4</b>
DH11   Step-over Security Door Hinge	<b>4</b>
DH11SS   Step-over Security Door Hinge - Stainless Steel	<b>5</b>
DH910   Hinge Packer	<b>5</b>

## **STAINLESS STEEL** | DOOR HINGES

DH18   316 Grade SS Sintered Bush Fast Fix Interfold	<b>6</b>
DH19   Stainless Sintered Bearing Fast Fix Interfold	<b>6</b>
DH60   All Purpose Fast Fix Hinge	<b>7</b>
DH78   Stainless Sintered Bearing Interfold	<b>8</b>

## **ALUMINIUM** | DOOR HINGES

DH1   Aluminium Concealed Hinge	<b>8</b>
DH3   Aluminium Fast Fix Interfold	<b>9</b>
DH9   Aluminium Interfold Partition Fast Fix	<b>9</b>
DH22   Aluminium Heavy Duty Interfold Hinge	<b>10</b>
DH26   Aluminium Shop front Fast Fix Hinge	<b>10</b>
DH27   Aluminium Interfold Hinge	<b>11</b>
DH176   Aluminium Interfold Hinge	<b>11</b>

## **COMMERCIAL** | DOOR HINGES

DH104   Heavy Duty Aluminium Fast Fix	<b>12</b>
DH114   Heavy Duty Aluminium Fast Fix	<b>12</b>
DH40X   Universal Adjustable Hinge	<b>13</b>

## **LIFT OFF** | DOOR HINGES

DH15   Aluminium Lift-off Parliament Hinge - Left Hand	<b>14</b>
DH17   Aluminium Lift-off Parliament Hinge - Right Hand	<b>14</b>
DH28/L   Aluminium Left Hand Lift-Off Door Hinge	<b>15</b>
DH28/R   Aluminium Right Hand Lift-Off Door Hinge	<b>15</b>

## DH10 | STEP-OVER SECURITY DOOR HINGE (W/ LUG)

<b>APPLICATION</b>	Aluminium extrusion security doors
<b>MATERIAL</b>	Mild steel
<b>FINISH</b>	Standard & non standard powder coat
<b>PIN TYPE</b>	Mild Steel
<b>INTERFACE</b>	Pressed
<b>FIXINGS</b>	8G screws (not included)

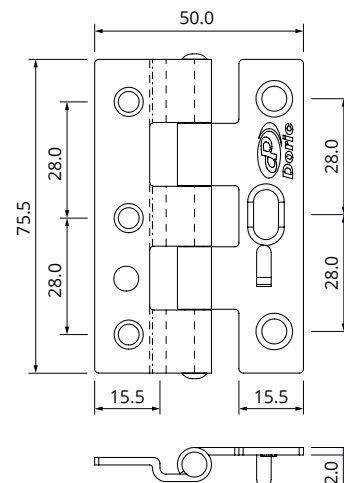

ORDER CODE	COLOUR/FINISH
MDH10	Powder coat - Standard Powder coat - Non standard

## DH11 | STEP-OVER SECURITY DOOR HINGE

<b>APPLICATION</b>	Aluminium extrusion security doors
<b>MATERIAL</b>	Mild steel
<b>FINISH</b>	Powder coat, or zinc plated
<b>PIN TYPE</b>	Mild steel
<b>INTERFACE</b>	Pressed
<b>FIXINGS</b>	8G screws (not included)

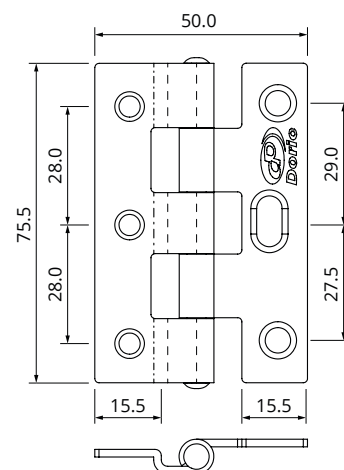

ORDER CODE	COLOUR/FINISH
MDH11	Powder coat - Standard Powder coat - Non standard
9003278ZN	Zinc

## DH11SS | STEP-OVER SECURITY DOOR HINGE - STAINLESS STEEL

<b>APPLICATION</b>	Aluminium extrusion security doors
<b>MATERIAL</b>	304 Stainless steel
<b>FINISH</b>	Brushed stainless steel
<b>PIN TYPE</b>	304 Stainless steel
<b>INTERFACE</b>	Pressed
<b>FIXINGS</b>	8G screws (not included)

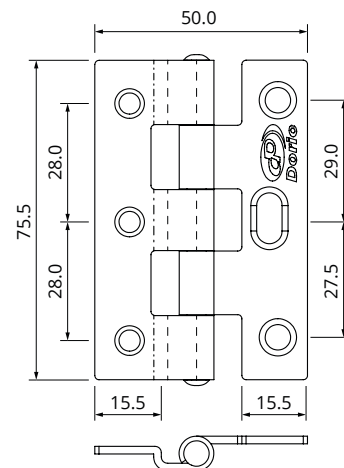

ORDER CODE	COLOUR/FINISH
9003279TE	Stainless steel

## DH910 | HINGE PACKER

<b>APPLICATION</b>	DH10 & DH11
<b>MATERIAL</b>	Nylon
<b>FINISH</b>	Black
<b>FIXINGS</b>	Not included

ORDER CODE	COLOUR/FINISH
9000160	Mill Black

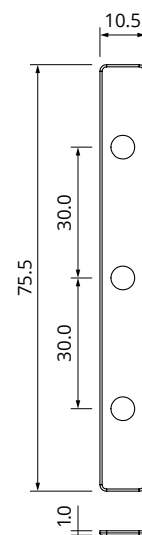

## DH18 | 316 GRADE SS SINTERED BUSH FAST FIX INTERFOLD

<b>APPLICATION</b>	Coastal and demanding environments
<b>SUITS</b>	Timber and metal doors
<b>MATERIAL</b>	316 grade stainless steel
<b>FINISH</b>	Satin stainless
<b>PIN TYPE</b>	4.5mm 304 stainless
<b>FIXINGS</b>	8G CSK Rivets (not included)
<b>ORDER CODE</b>	<b>COLOUR/FINISH</b>
9011620	Satin stainless

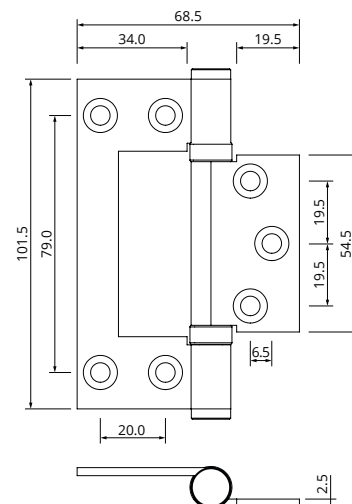

## DH19 | STAINLESS SINTERED BEARING FAST FIX INTERFOLD

<b>APPLICATION</b>	Timber and metal doors
<b>MATERIAL</b>	304 grade stainless steel
<b>FINISH</b>	Satin stainless steel
<b>PIN TYPE</b>	4.5mm 304 stainless
<b>INTERFACE</b>	Sintered bush
<b>FIXINGS</b>	8G Screws (Included)
<b>ORDER CODE</b>	<b>PRODUCT</b>
90011336	DH19 - Pair

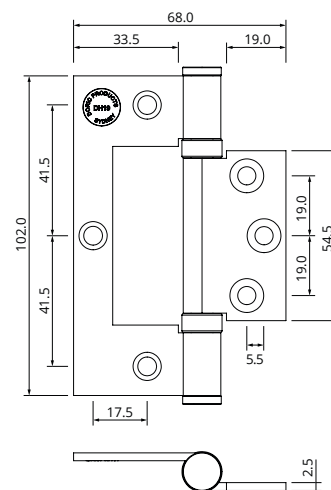

# DH60 | ALL PURPOSE FAST FIX HINGE

The DH60 is Doric's popular all purpose hinge suitable for commercial & residential applications in timber and aluminium doors & frames. Manufactured from premium grade 304 stainless steel the DH60 is well placed to withstand everyday environments.

While there are numerous hinges on the market today, few have surpassed 1000 hours of Neutral Salt Spray testing.

## FEATURES

- Fast fix hinge type
- Stainless steel finish
- Suited to internal and external hinge applications

## ADVANTAGES

- Easy to install
- Suitable for timber and aluminium residential door applications



## PRODUCT DETAILS

<b>APPLICATION</b>	Aluminium to aluminium application
<b>MATERIAL</b>	304 grade stainless steel
<b>FINISH</b>	Satin stainless steel
<b>HINGED PIN</b>	304 grade stainless steel
<b>PIN TYPE</b>	Pressed & capped
<b>INTERFACE</b>	Hardened steel ball bearing
<b>FIXINGS</b>	Not included
<b>ORDER CODE</b>	<b>COLOUR/FINISH</b>
9042977	Satin stainless steel

## TESTING

- **AS2331.3.1 for Corrosion Performance:**  
Completed 1000 hours of salt bath testing

## DIMENSIONS

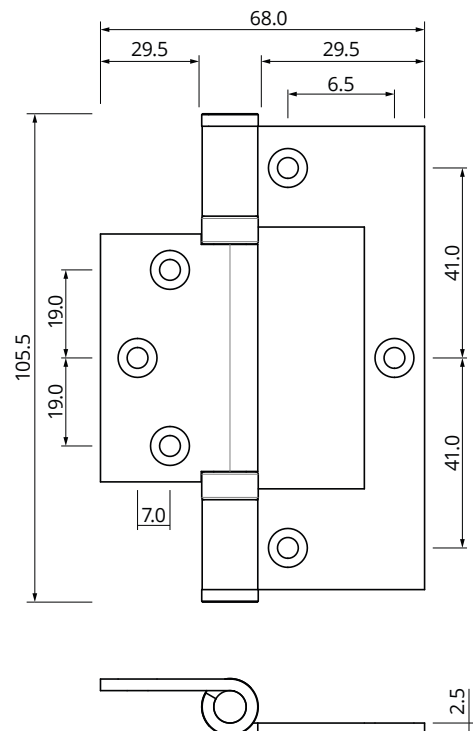

## DH78 | STAINLESS SINTERED BEARING INTERFOLD

<b>APPLICATION</b>	Timber and metal doors
<b>MATERIAL</b>	304 grade stainless steel
<b>FINISH</b>	Satin stainless steel
<b>PIN TYPE</b>	4.7mm 304 Stainless
<b>PIN TYPE</b>	Pressed & capped
<b>INTERFACE</b>	Sintered stainless steel bearing
<b>FIXINGS</b>	8G CSK rivets (not include)
<b>ORDER CODE</b>	<b>COLOUR/FINISH</b>
9001383	Satin stainless steel

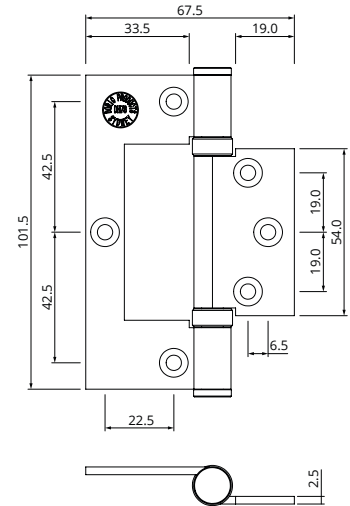

**NOTE:** Product is on run out, only available while stocks last.

## DH1 | ALUMINIUM CONCEALED HINGE

<b>APPLICATION</b>	For metal doors to metal frames
<b>MATERIAL</b>	6063 T5 grade 1 aluminium
<b>FINISH</b>	Clear anodised and powder coat
<b>PIN TYPE</b>	4.75mm 304 stainless
<b>INTERFACE</b>	Nylon cap & bushes
<b>FIXINGS</b>	Not included
<b>ORDER CODE</b>	<b>COLOUR/FINISH</b>
MDH1	Powder coat - Standard Powder coat - Non standard
MDH1	Clear Anodised

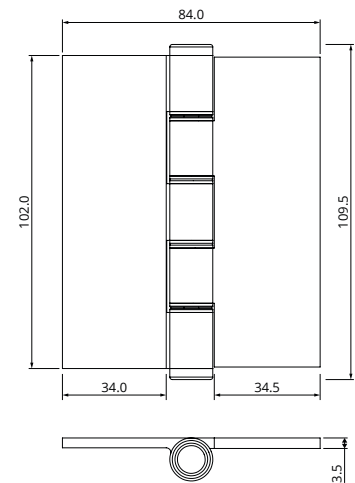



## DH3 | ALUMINIUM FAST FIX INTERFOLD

<b>APPLICATION</b>	For metal doors to metal frames
<b>MATERIAL</b>	6063 T5 grade 1 aluminium
<b>FINISH</b>	Clear anodised and powder coat
<b>PIN TYPE</b>	4.75mm 304 stainless
<b>INTERFACE</b>	Nylon cap & bushes
<b>FIXINGS</b>	10G under - cut corner sunk screws (not included)

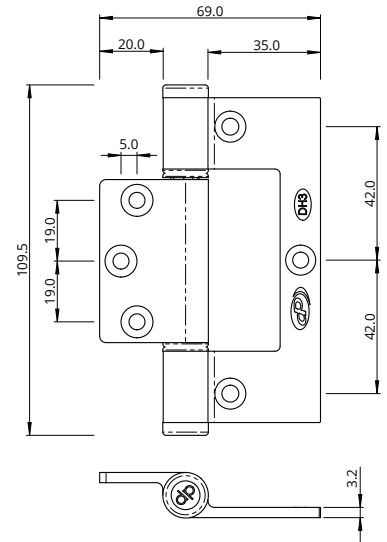

ORDER CODE	COLOUR/FINISH
MDH3	Powder coat - Standard Powder coat - Non standard
MDH3	Clear Anodised

## DH9 | ALUMINIUM INTERFOLD PARTITION FAST FIX

<b>APPLICATION</b>	For timber doors to aluminium door frames
<b>MATERIAL</b>	6063 T5 grade 1 aluminium
<b>FINISH</b>	Clear anodised and powder coat
<b>PIN TYPE</b>	4.75mm 304 stainless
<b>INTERFACE</b>	Nylon bushes
<b>FIXINGS</b>	10G under - cut counter sunk screws (not included)

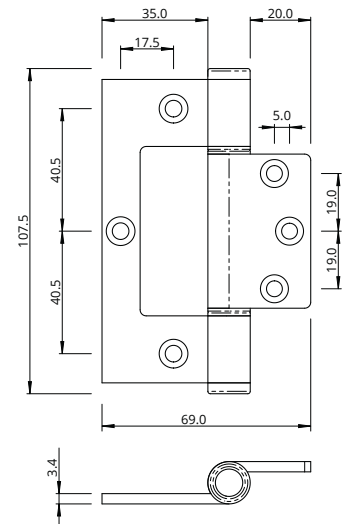

ORDER CODE	COLOUR/FINISH
9001325CA	Clear Anodised
9001325SB	Satin Black

## DH22 | ALUMINIUM HEAVY DUTY INTERFOLD HINGE

<b>APPLICATION</b>	For aluminium & timber doors/frames
<b>MATERIAL</b>	6063 T5 grade 1 aluminium
<b>FINISH</b>	Clear anodised and powder coat
<b>PIN TYPE</b>	6.4mm 316 stainless
<b>INTERFACE</b>	Nylon bushes & caps
<b>FIXINGS</b>	10G under-cut counter sunk screws (not included)

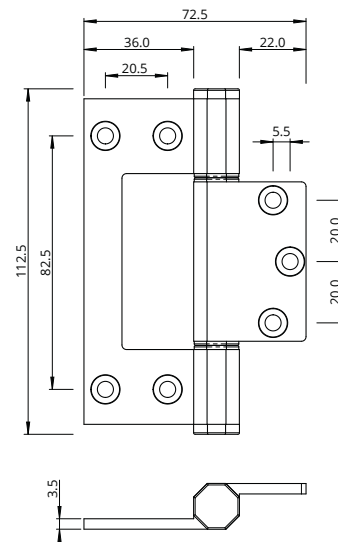

ORDER CODE	COLOUR/FINISH
MDH22	Powder coat - Standard Powder coat - Non standard
MDH22	Clear Anodised

## DH26 | ALUMINIUM SHOP FRONT FAST FIX HINGE

<b>APPLICATION</b>	For metal doors to metal frame fixing
<b>MATERIAL</b>	6063 T5 grade 1 aluminium
<b>FINISH</b>	Clear anodised and powder coat
<b>PIN TYPE</b>	4.75mm 304 stainless
<b>INTERFACE</b>	Nylon bushes & caps
<b>FIXINGS</b>	10G under - cut counter sunk screws (not included)

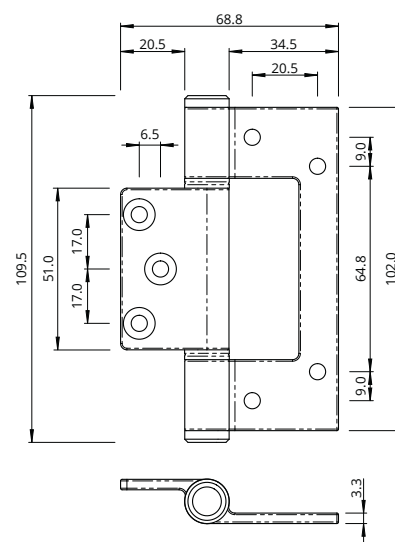

ORDER CODE	COLOUR/FINISH
MDH26	Powder coat - Standard Powder coat - Non standard
MDH26	Clear Anodised

## DH27 | ALUMINIUM INTERFOLD HINGE

<b>APPLICATION</b>	For both timber and metal doors to metal frames
<b>MATERIAL</b>	6063 T5 grade 1 aluminium
<b>FINISH</b>	Clear anodised and powder coat
<b>PIN TYPE</b>	4.75mm 304 stainless
<b>INTERFACE</b>	Nylon bushes & caps
<b>FIXINGS</b>	10G under-cut counter sunk screws (not included)

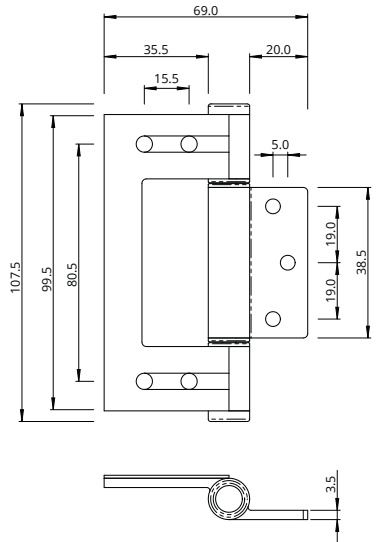

ORDER CODE	COLOUR/FINISH
MDH27	Powder coat - Standard Powder coat - Non standard
MDH27	Clear Anodised

## DH176 | ALUMINIUM INTERFOLD HINGE

<b>APPLICATION</b>	Light doors and windows
<b>MATERIAL</b>	Alloy: High strength T.6 minimum tensile
<b>FINISH</b>	Clear anodised, or Satin Black
<b>HINGED PIN</b>	4mm 304 Stainless steel
<b>PIN TYPE</b>	Pressed
<b>INTERFACE</b>	Nylon bushes
<b>FIXINGS</b>	10G screw (Not included)
<b>END CAPS</b>	Aluminium interference fit caps

The DH176 is a compact heavy duty hinge which allows for controlled rotation of the window or door. It is a fast fix aluminium hinge that is suitable for windows and small doors.

### TESTING

- **Cycle Testing:** Completed 50,000 cycles

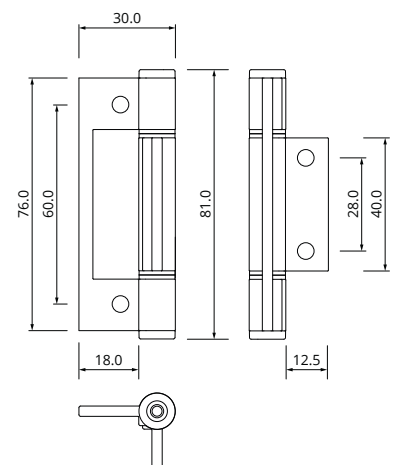

ORDER CODE	PRODUCT	COLOUR
9049263CA	DH176C/A	Clear Anodised
9049263SB	DH176BLK	Satin Black

## DH104 | HEAVY DUTY ALUMINIUM FAST FIX

<b>APPLICATION</b>	Commercial & shopfront
<b>MATERIAL</b>	6063 - T5 Alloy
<b>FINISH</b>	Clear Anodised and Satin Black Powder coat
<b>PIN TYPE</b>	6mm 304 Stainless Steel
<b>INTERFACE</b>	Nylon bushes
<b>FIXINGS</b>	Cross fixed heavy duty. 10G fixing screws included
<b>KNUCKLES</b>	Squareline - Heavy duty
<b>ALUMINIUM END CAPS</b>	Interference Pressed Fit
<b>ORDER CODE</b>	<b>COLOUR/FINISH</b>
9042153	White

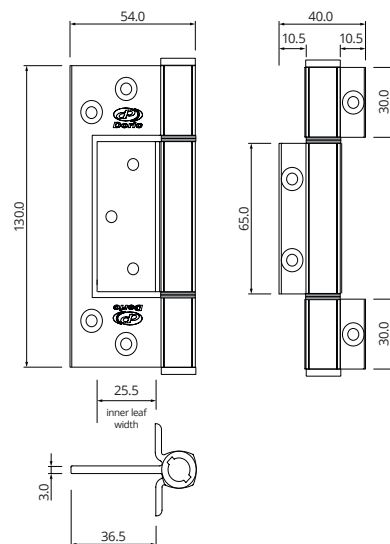

## DH114 | HEAVY DUTY ALUMINIUM FAST FIX

<b>APPLICATION</b>	Commercial & shopfront
<b>MATERIAL</b>	6063 - T5 Alloy
<b>FINISH</b>	Clear Anodised and Satin Black Powder coat
<b>PIN TYPE</b>	6mm 304 Stainless Steel
<b>INTERFACE</b>	Nylon bushes
<b>FIXINGS</b>	Cross fixed heavy duty. 10G fixing screws included
<b>KNUCKLES</b>	Squareline - Heavy duty
<b>ALUMINIUM END CAPS</b>	Interference Pressed Fit
<b>ORDER CODE</b>	<b>COLOUR/FINISH</b>
9046221	Clear Anodised
9046222	Satin Black

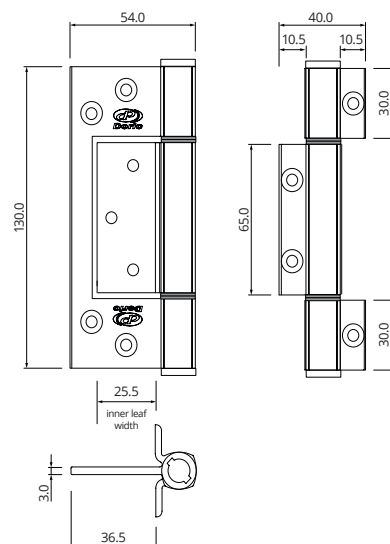

# DH40X | UNIVERSAL ADJUSTABLE HINGE

The DH40X is an award winning designed hinge with greater enhancements to better suit the growing trend of larger commercial doors.

No other hinge on the market allows for simple adjustments once fitted like the DH40X. It delivers style and performance with value for money.

## FEATURES

- Slimline modern design provides a non obtrusive and contemporary visual appeal
- Adjustable up to 6mm vertically and horizontally
- Metal dress cover plates conceal fixings
- Up to 180° degree door opening capacity allowing for 100% opening potential

## ADVANTAGES

- Universal fitting principals - Suitable for any installation where an interfold or butt style hinge can be used
- Surface mounting requires no specialised machining
- Bi-directional fixing system provides vastly superior load carrying capabilities
- Added security whereby hinge pins cannot be removed



## PRODUCT DETAILS

<b>APPLICATION</b>	Architectural & commercial doors	
<b>MATERIAL</b>	Alloy cast	
<b>FINISH</b>	Coastal Silver	
<b>PIN TYPE</b>	304 Stainless steel	
<b>INTERFACE</b>	Nylon bushes	
<b>FIXINGS</b>	8G Screws (Included)	
<b>ORDER CODE</b>	<b>PRODUCT</b>	<b>COLOUR</b>
9043848	DH40X	Silver

## DIMENSIONS

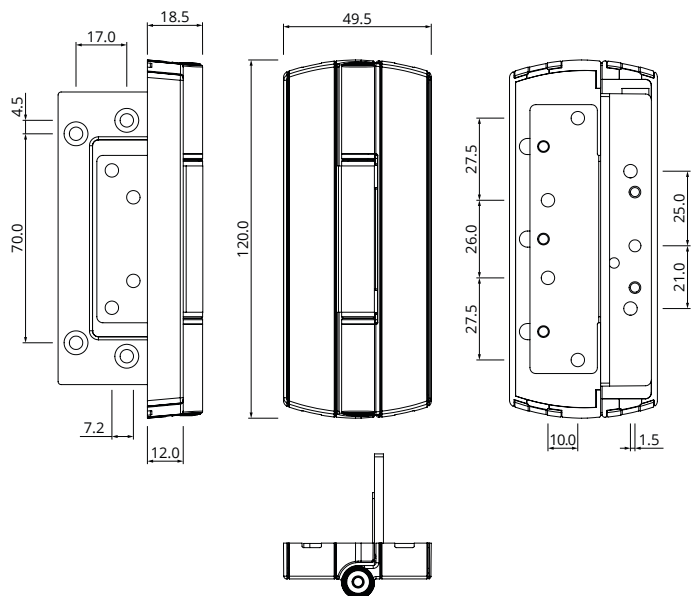

## DH15 | ALUMINIUM LIFT-OFF PARLIAMENT HINGE - LEFT HAND

<b>APPLICATION</b>	Open out doors to clear brick work & allow doors to open 180 degrees (lift-off when opened)
<b>MATERIAL</b>	Aluminium cast
<b>FINISH</b>	Powder coat
<b>HINGED PIN</b>	7.9mm 304 stainless steel
<b>PIN TYPE</b>	Pressed lift off
<b>INTERFACE</b>	Nylon bushes
<b>FIXINGS</b>	10G screws (not included)
<b>ORDER CODE</b>	<b>COLOUR/FINISH</b>
9103869	Satin Black
9003784WH	White
9101409	Silver

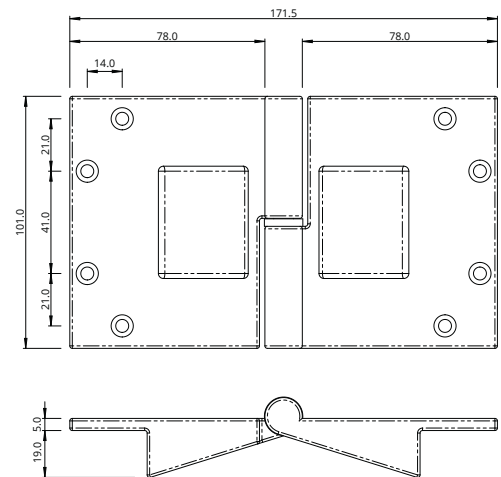

## DH17 | ALUMINIUM LIFT-OFF PARLIAMENT HINGE - RIGHT HAND

<b>APPLICATION</b>	Open out doors to clear brick work & allow doors to open 180 degrees (lift-off when opened)
<b>MATERIAL</b>	Aluminium cast
<b>FINISH</b>	Powder coat
<b>HINGED PIN</b>	7.9mm 304 stainless steel
<b>PIN TYPE</b>	Pressed lift off
<b>INTERFACE</b>	Nylon bushes
<b>FIXINGS</b>	10G screws (not included)
<b>ORDER CODE</b>	<b>COLOUR/FINISH</b>
9003785SB	Satin Black
9003785WH	White
9101408	Silver

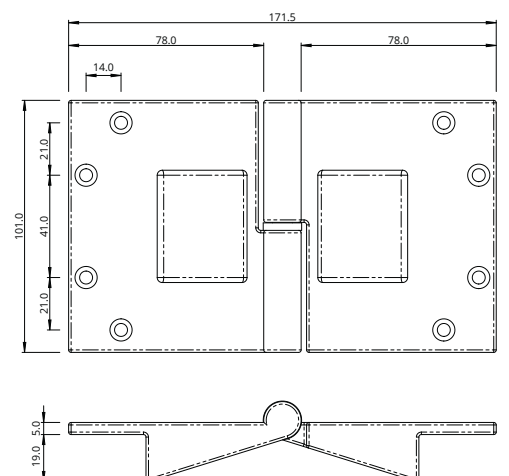

## DH28/L | ALUMINIUM LEFT HAND LIFT-OFF DOOR HINGE

<b>APPLICATION</b>	For doors which need to be removed when opened
<b>MATERIAL</b>	6063 T5 grade 1 aluminium
<b>FINISH</b>	Clear anodised and powder coat
<b>HINGED PIN</b>	7.9mm 304 stainless
<b>PIN TYPE</b>	Pressed lift off
<b>INTERFACE</b>	Nylon bushes
<b>FIXINGS</b>	10G screws (not included)

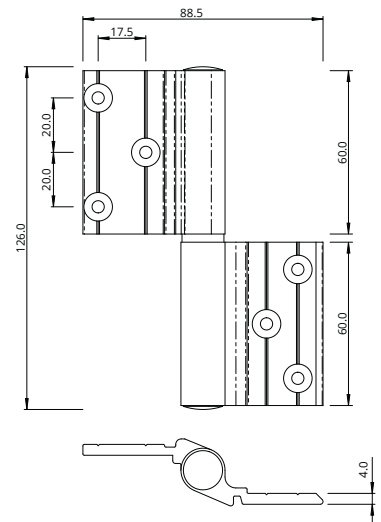

ORDER CODE	COLOUR/FINISH
9004303SB	Satin Black
9004303WH	White
9004303CA	Clear Anodised

## DH28/R | ALUMINIUM RIGHT HAND LIFT-OFF DOOR HINGE

<b>APPLICATION</b>	For doors which need to be removed when opened
<b>MATERIAL</b>	6063 T5 grade 1 aluminium
<b>FINISH</b>	Clear anodised and powder coat
<b>HINGED PIN</b>	7.9mm 304 stainless
<b>PIN TYPE</b>	Pressed lift off
<b>INTERFACE</b>	Nylon bushes
<b>FIXINGS</b>	10G screws (not included)

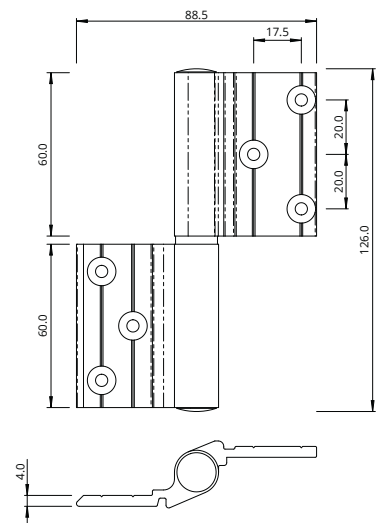

ORDER CODE	COLOUR/FINISH
9004304SB	Satin Black
9004304WH	White
9004304CA	Clear Anodised

# INNOVATORS

OF HARDWARE FOR WINDOWS AND DOORS

## INDEX

Code	Product/Description	Page
DH1	Aluminium Concealed Hinge	8
DH10	Step-over Security Door Hinge (w/ lug)	4
DH104	Heavy Duty Aluminium Fast Fix	12
DH11	Step-over Security Door Hinge	4
DH114	Heavy Duty Aluminium Fast Fix	12
DH11SS	Step-over Security Door Hinge - Stainless Steel	5
DH15	Aluminium Lift-off Parliament Hinge - Left Hand	14
DH17	Aluminium Lift-off Parliament Hinge - Right Hand	14
DH176	Aluminium Interfold Hinge	11
DH18	316 Grade SS Sintered Bush Fast Fix Interfold	6
DH19	Stainless Sintered Bearing Fast Fix Interfold	6
DH22	Aluminium Heavy Duty Interfold Hinge	10
DH26	Aluminium Shop front Fast Fix Hinge	10
DH27	Aluminium Interfold Hinge	11
DH28/L	Aluminium Left Hand Lift-Off Door Hinge	15
DH28/R	Aluminium Right Hand Lift-Off Door Hinge	15
DH3	Aluminium Fast Fix Interfold	9
DH40X	Universal Adjustable Hinge	13
DH60	All Purpose Fast Fix Hinge	7
DH78	Stainless Sintered Bearing Interfold	8
DH9	Aluminium Interfold Partition Fast Fix	9
DH910	Hinge Packer	5

### SYDNEY

38 Redfern St,  
Wetherill Park  
Sydney, NSW 2164  
Australia  
Ph: +61 2 9609 2555  
[www.doric.com.au](http://www.doric.com.au)

### AUCKLAND

26/C Triton Drive,  
Albany, North Shore,  
Auckland 0632  
New Zealand  
Ph: +64 9 415 5535  
[www.doric.co.nz](http://www.doric.co.nz)

### KUALA LUMPUR

Unit 6, Level 4, SetiaWalk Mall (Block K),  
SetiaWalk, Persiaran Wawasan,  
Pusat Bandar Puchong,  
47160 Puchong, Selangor, Malaysia  
Ph: +603 8602 2100  
[www.doric.com.my](http://www.doric.com.my)



**ALCHIN  
LONG  
GROUP**

